

**Tower Crane  
Grue à tour**

# **Turmdrehkran 26 K**

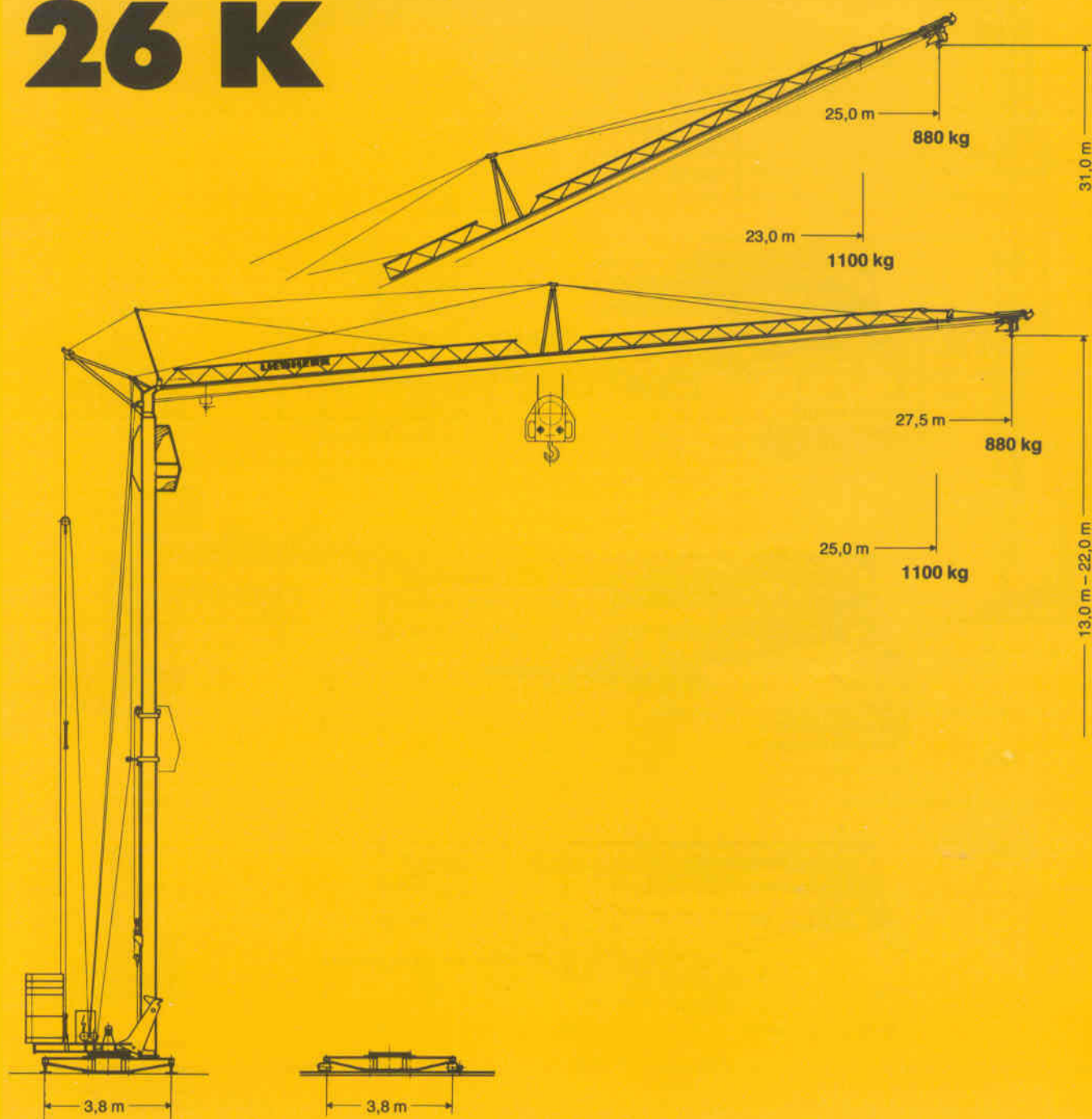

# **LIEBHERR**

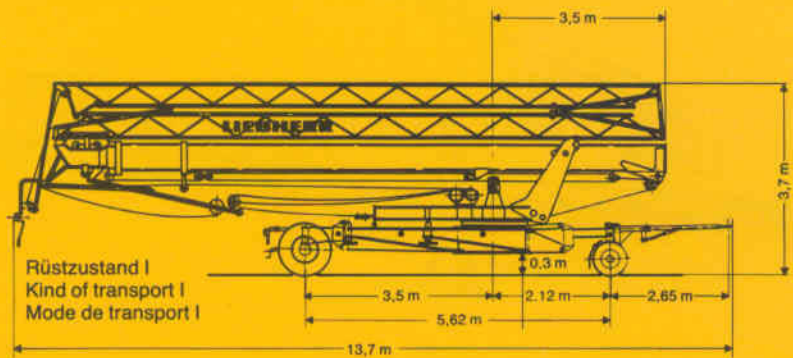
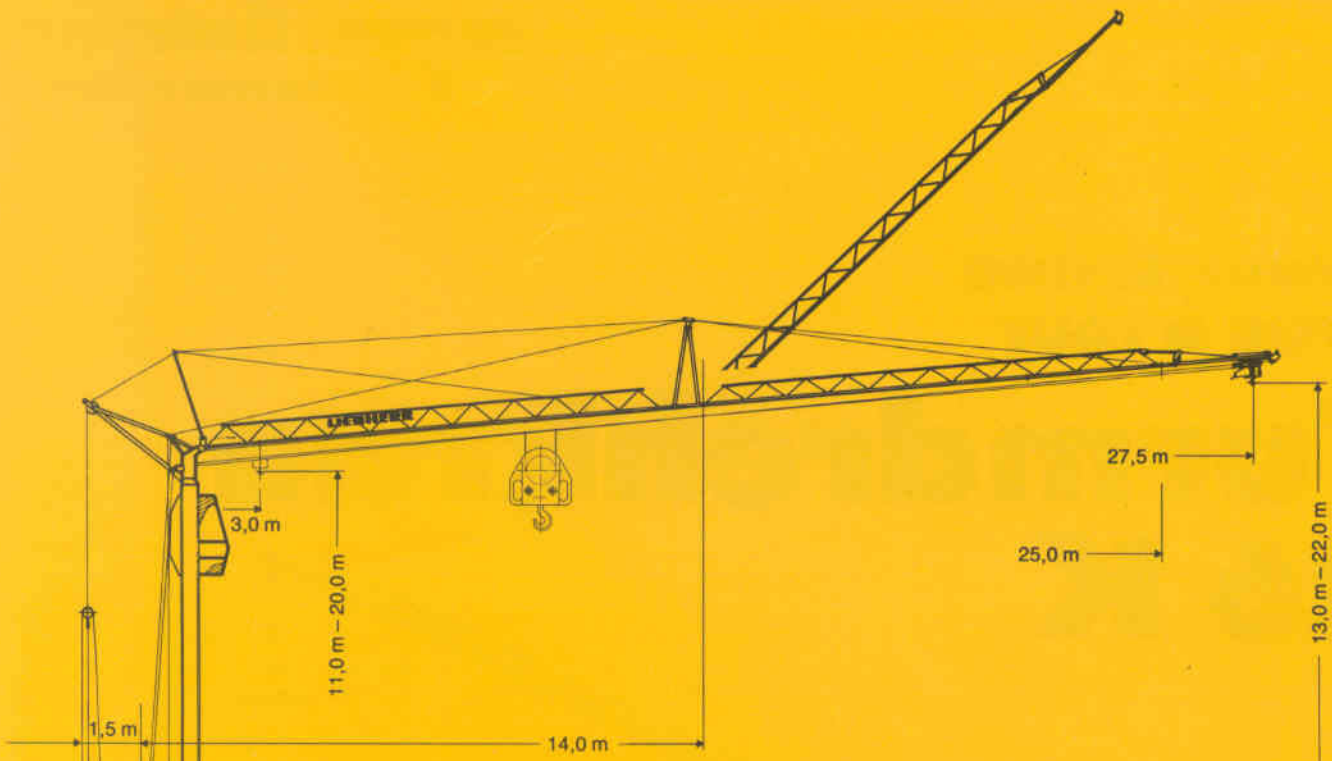

Transportgewicht 13000 kg  
Transport weight  
Poids de transport

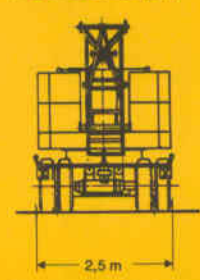
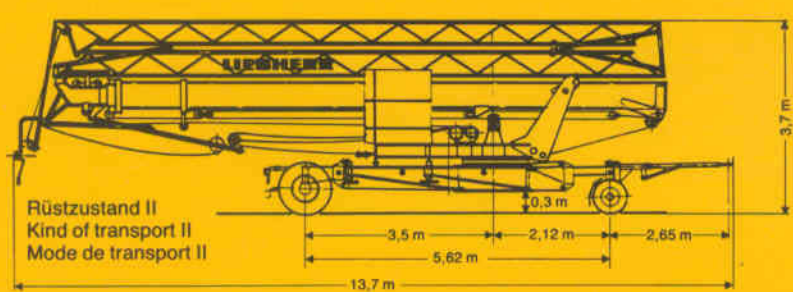

Transportgewicht 18800 kg  
Transport weight  
Poids de transport

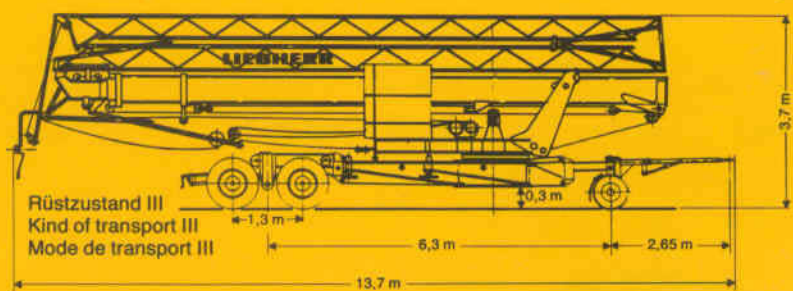

Transportgewicht 20000 kg  
Transport weight  
Poids de transport

# 26 K

# Gewicht

## Weight / Poids

Max. Eckkraft in Betrieb Max. corner pressure in operation Réaction max. par angle en service	140 kN*
Max. Eckkraft außer Betrieb Max. corner pressure out of operation Réaction max. par angle hors service	88 kN

Gegengewicht ca. Counter weight approx. Contrepoids env.	12860 kg
Konstruktionsgewicht ca. Dead weight approx. Poids de la construction env.	10000 kg

\* Umrechnung der Einheiten für Kräfte 1 kp = 10 N; 10 kN = 1 Mp. / Conversion of the units for forces. / Conversion des unités des forces.

# Ausladung und Tragfähigkeit





## Radius and capacity / Portée et charge

Auslegerlänge Length of jib Longueur de flèche m	Max. Tragfähigkeit Max. capacity Charge maxi. m/kg	Ausladung und Tragfähigkeit Radius and capacity Portée et charge m/kg													
		11,0	12,0	14,0	16,5	17,6	18,0	19,0	20,0	21,0	23,0	24,0	25,0	26,0	27,5
27,5	3,0 – 10,9 2500	2500	2450	2030	1650	1535	1490	1395	1310	1230	1100	1045	995	945	880
25,0	3,0 – 11,8 2500	2500	2500	2235	1825	1690	1650	1540	1445	1365	1230	1155	1100		

Auslegerlänge Length of jib Longueur de flèche m	Max. Tragfähigkeit Max. capacity Charge maxi. m/kg	Ausladung und Tragfähigkeit Radius and capacity Portée et charge m/kg											Auslegersteilstellung 25° Elevated jib 25° Flèche inclinée 25°		
		11,0	12,0	14,0	16,5	17,6	18,0	19,0	20,0	21,0	23,0	24,0	25,0		
27,5	2,9 – 17,6 1250	1250	1250	1250	1250	1250	1250	1250	1170	1100	995	930	880		
25,0	2,9 – 19,0 1250	1250	1250	1250	1250	1250	1250	1250	1250	1220	1100				

# Geschwindigkeiten

## Speeds / Vitesses

	U/min 0 – 0,9 st./min tr./mn	1,5 kW
	5,0 / 30,0 m/min	1,3 / 4,0 kW
	25,0 m/min	2 × 1,0 kW
	0 – 45° ca. 30 sec.	

Hubwerk Hoist unit Mécanisme de levage	Stufe Step Cran	kg	m/min
	1	2500	5,0
	2	2500	20,0
	3	1250	40,0

Kabelquerschnitt bei 380 V bis 28,0 m 4 × 10 mm<sup>2</sup>  
Cross section of cable up to  
Section de câble à jusqu'à

Betriebsspannung 380 V  
Operating voltage  
Tension de service

Frequenz 50 Hz  
Frequency  
Fréquence

Gesamtmotorenleistung max. 16,5 kW / 20,6 kVA  
Total motor output  
Puissance totale des moteurs

# Technische Daten - Technical data

# Caractéristiques techniques

# Aufstellvorgang

Erection procedure / Déroulement de montage

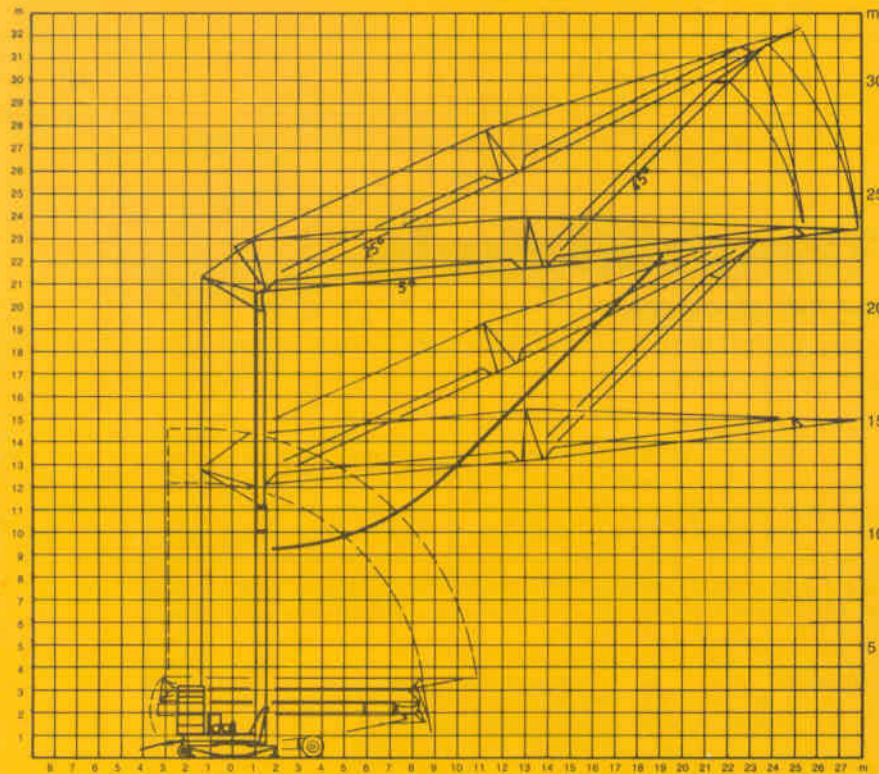

Ballasterausladung 4,5 m  
Ballasting radius 4,5 m  
Portée pour dispositif de lestage 4,5 m

## Kolli-Liste

Packing list / Liste de colisage

Pos. Item Rep.	Anzahl Quantity Qté.	Benennung Description Désignation		Länge m Length m Longueur m	Breite m Width m Largeur m	Höhe m Height m Hauteur m	Einzelgew. kg Unit weight kg Poids unitaire kg	Gesamtgew. kg Total weight kg Poids total kg
1	1	Ausleger-Verlängerung 25,0 m – 27,5 m Jib extension Rallonge de la flèche		2,50	1,10	0,40		83
2	1	Transportachse vorne Tra 50 KW 1 Road transport axle front Essieux de transport avant		3,10	1,42	0,98		465
3	1	Transportachse vorne Tra 100 KY 1 Road transport axle front Essieux de transport avant		3,00	1,13	0,97		660
4	1	Transportachse hinten Tra 120 GY 1 Road transport axle behind Essieux de transport arrière		1,90	2,50	1,05		1150
5	1	Transportachse hinten Tra 200 GZ 3 Road transport axle behind Essieux de transport arrière		3,10	2,50	1,10		2600
6	1	Kiste mit Seilen und Kleinteilen Case with ropes and small parts Caisse avec câbles et pièces détachées		1,00	0,80	1,00		450

Datenblatt Nr. 120 P – 2422 – FEM – 2.85  
Data sheet  
Feuille de caractéristiques

Konstruktionsänderungen vorbehalten!  
Subject to alterations!  
Sous réserves de modifications!

Printed in Austria

Nehmen Sie Kontakt auf mit  
Contact

Mettez-vous en rapport avec

LIEBHERR-WERK BISCHOFSHOFEN GES. MBH, A-5500 Bischofshofen/Salzburg, Telefon (06462) 2561-0, Telex 067706  
LIEBHERR-EXPORT AG, CH-5415 Nussbaumen/AG, Telefon (056) 820211-16, Telex 53578